

48"

Item Number:

500-V48-HON

JAMES MARTIN

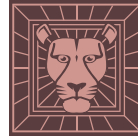

VANITIES™

Malibu 48" Cabinet

Diagrams with Dimensions
page 01 of 03

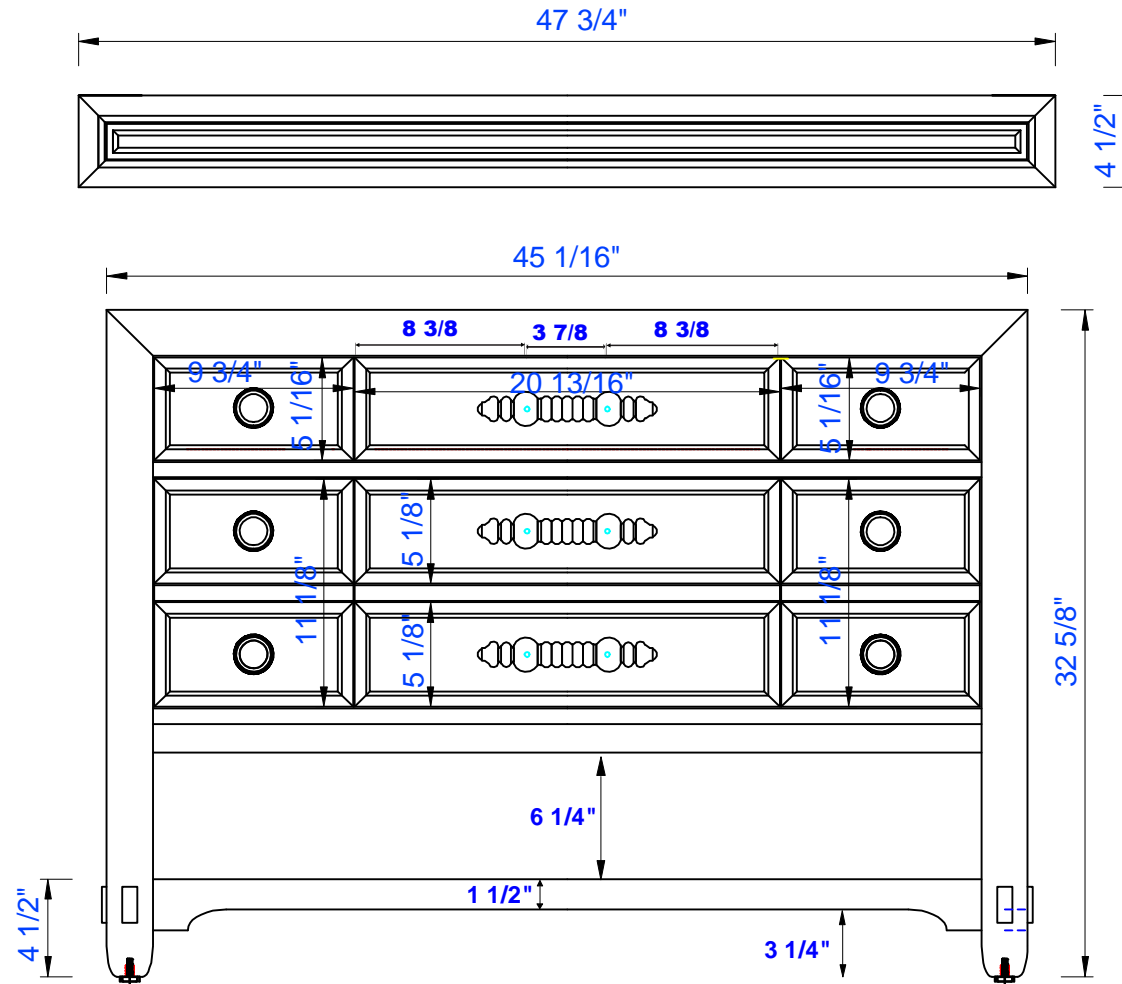

NOTE ONE: Countertops are not shown in these diagrams. (Cabinet Only)

NOTE TWO: Wood Backsplash (Shown) is designed for the molding detail to align with sinks in James Martin's Optional Countertops. Customers' own countertops and sinks may align differently.

Please consult our website for Countertop Diagrams: www.jamesmartinvanities.com

Version: 202005

48"

Item Number:
500-V48-HON

JAMES MARTIN

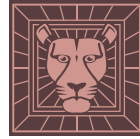

VANITIES™

Malibu 48" Cabinet

Diagrams with Dimensions
page 02 of 03

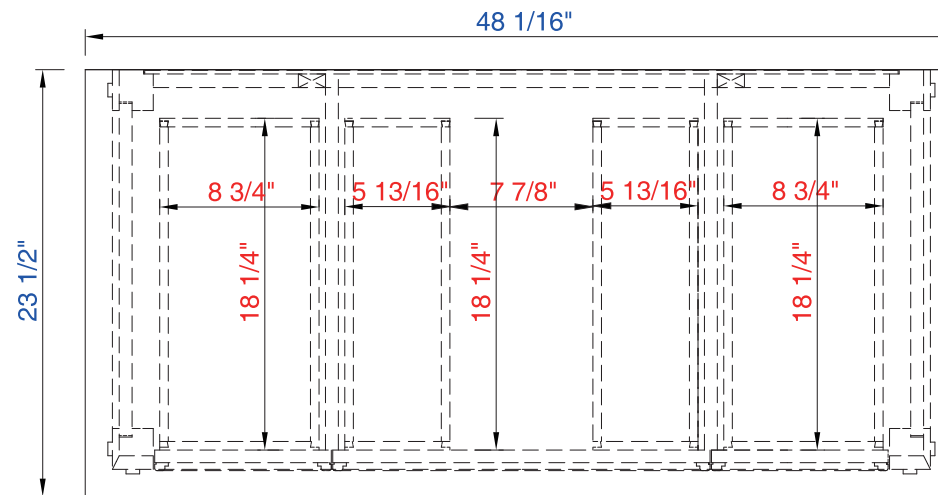
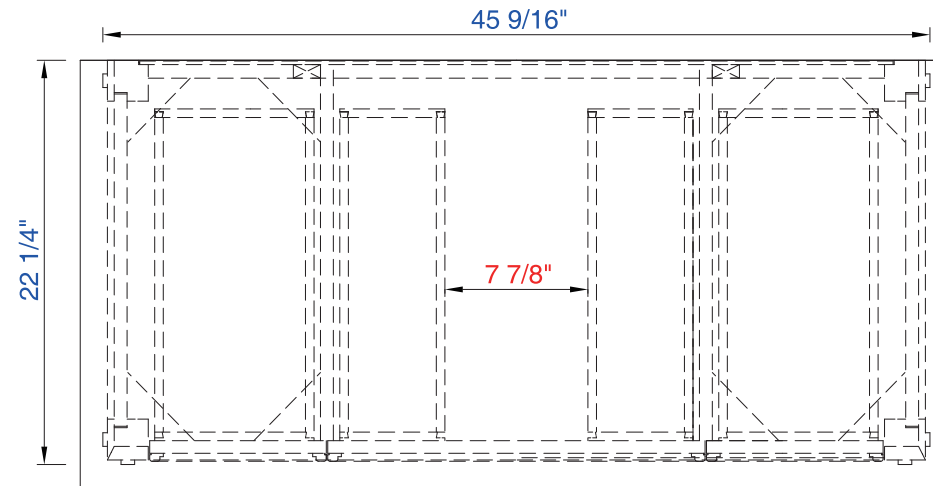

NOTE ONE: Countertops are not shown in these diagrams. (Cabinet Only)

Version: 202005

48"

Item Number:

500-V48-HON

JAMES MARTIN

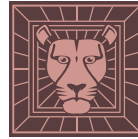

VANITIES™

Malibu 48" Cabinet

Diagrams with Dimensions
page 03 of 03

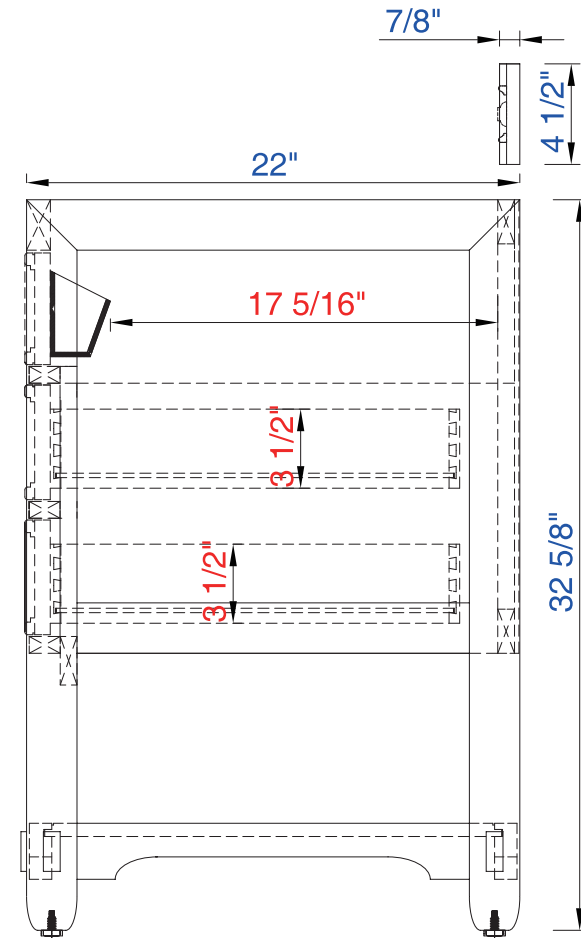
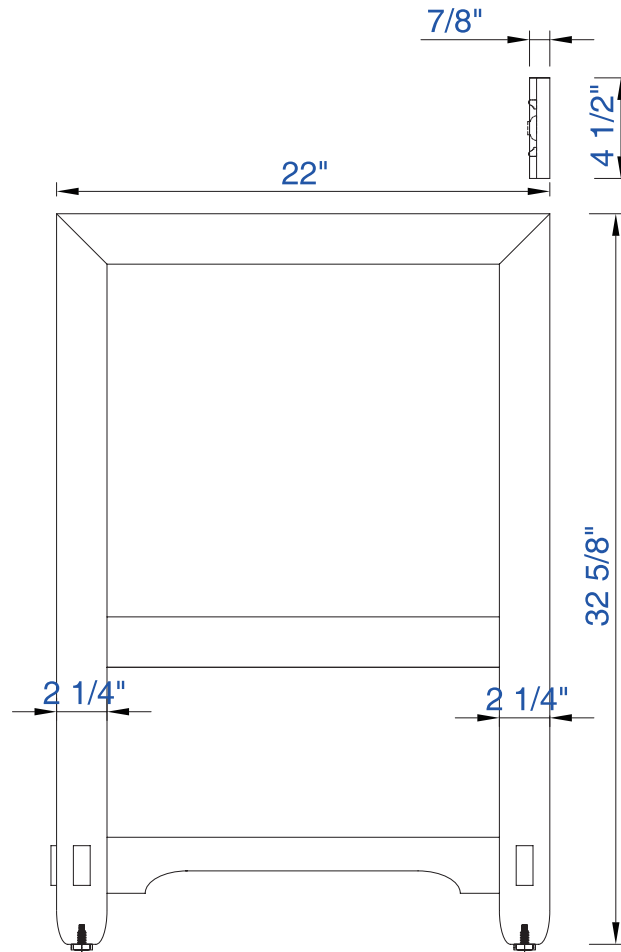

NOTE ONE: Countertops are not shown in these diagrams. (Cabinet Only)

NOTE TWO: Wood Backsplash (Shown) is designed for the molding detail to align with sinks in James Martin's Optional Countertops. Customers' own countertops and sinks may align differently.

Please consult our website for Countertop Diagrams: www.jamesmartinvanities.com

Version: 202005

1220mm

Item Number:
500-V48-HON

JAMES MARTIN

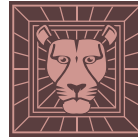

VANITIES™

Malibu 1220mm Cabinet

Diagrams with Dimensions
page 01 of 03

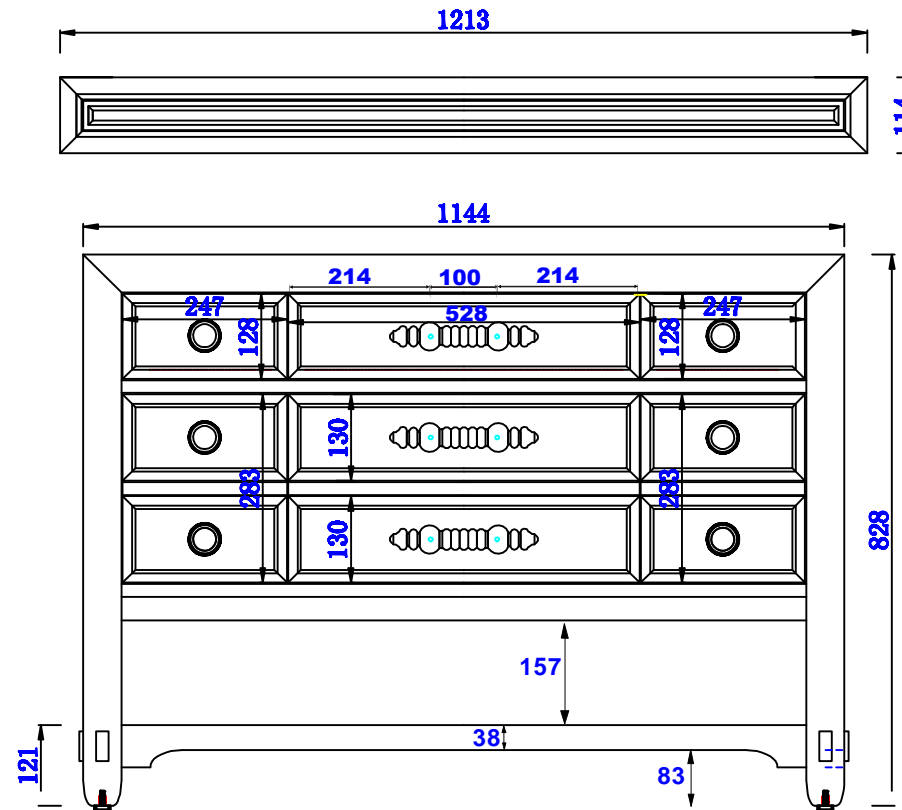

NOTE ONE: Countertops are not shown in these diagrams. (Cabinet Only)

NOTE TWO: Wood Backsplash (Shown) is designed for the molding detail to align with sinks in James Martin's Optional Countertops. Customers' own countertops and sinks may align differently.

Please consult our website for Countertop Diagrams: www.jamesmartinvanities.com

Version: 202005

1220mm

Item Number:
500-V48-HON

JAMES MARTIN



VANITIES™

Malibu 1220mm Cabinet

Diagrams with Dimensions
page 02 of 03

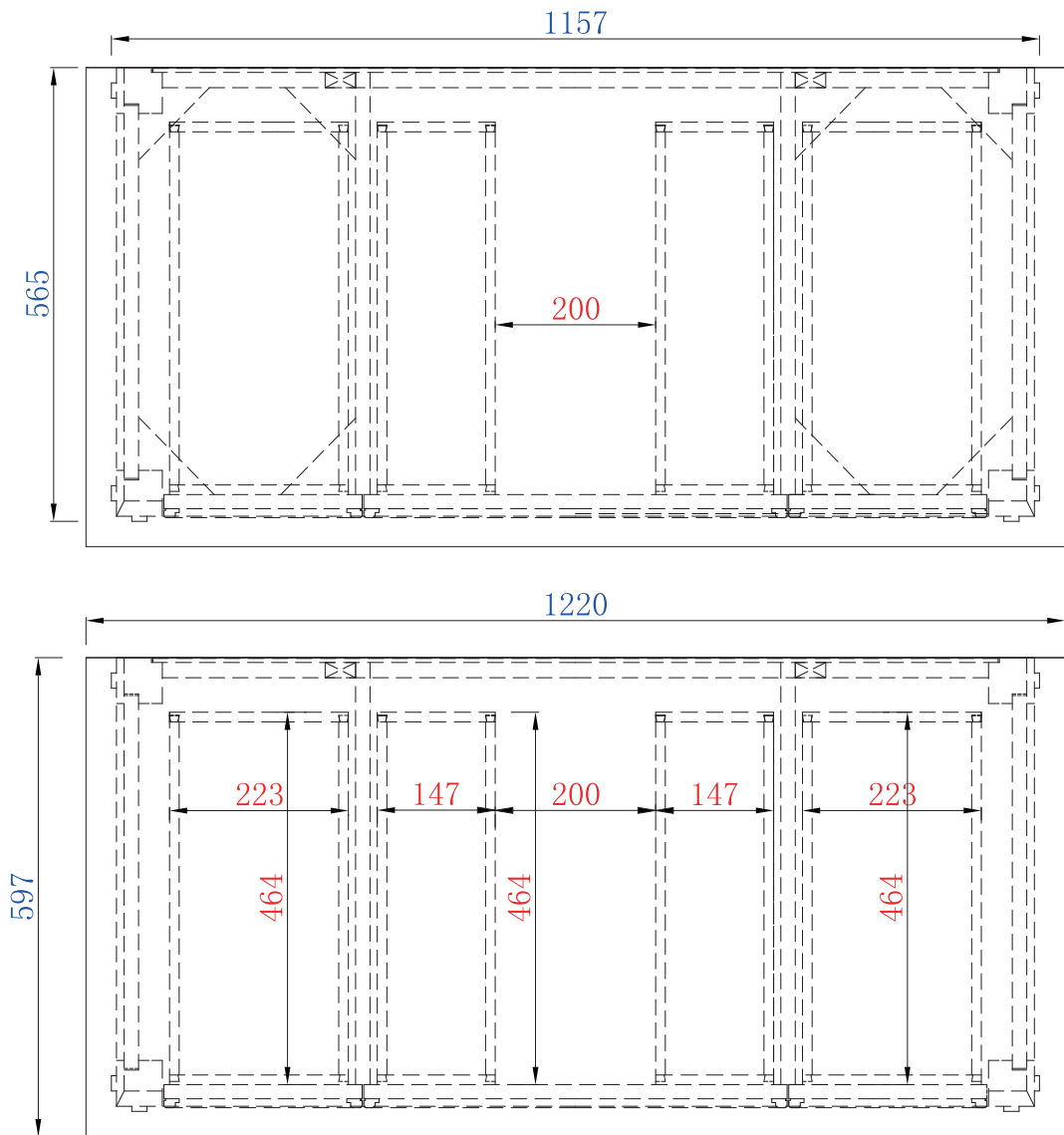

NOTE ONE: Countertops are not shown in these diagrams. (Cabinet Only)

Version: 202005

1220mm

Item Number:
500-V48-HON

JAMES MARTIN



VANITIES™

Malibu 1220mm Cabinet

Diagrams with Dimensions
page 03 of 03

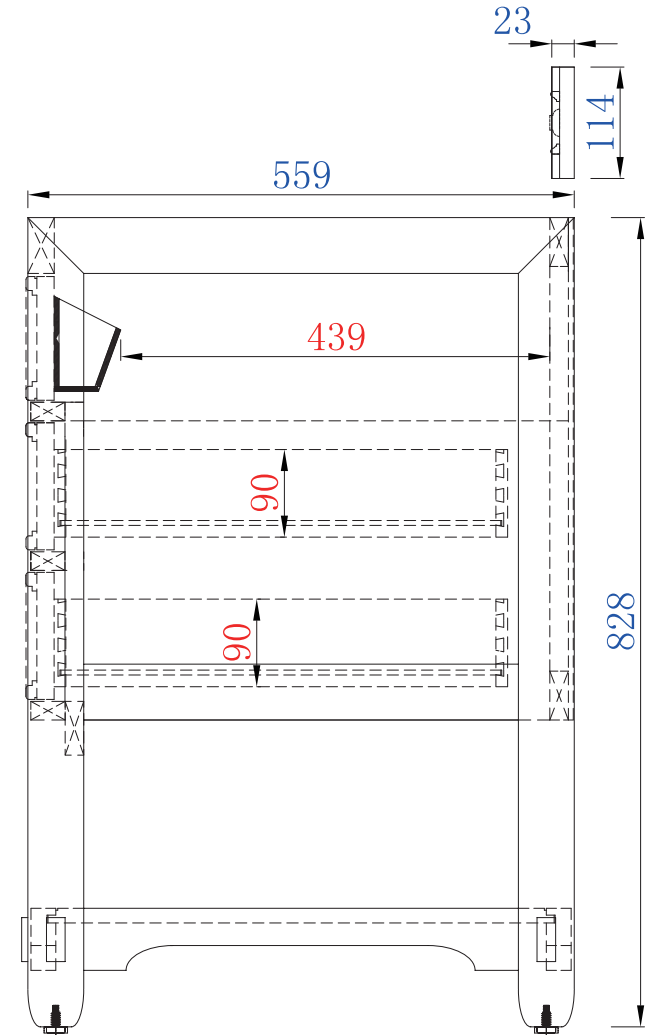
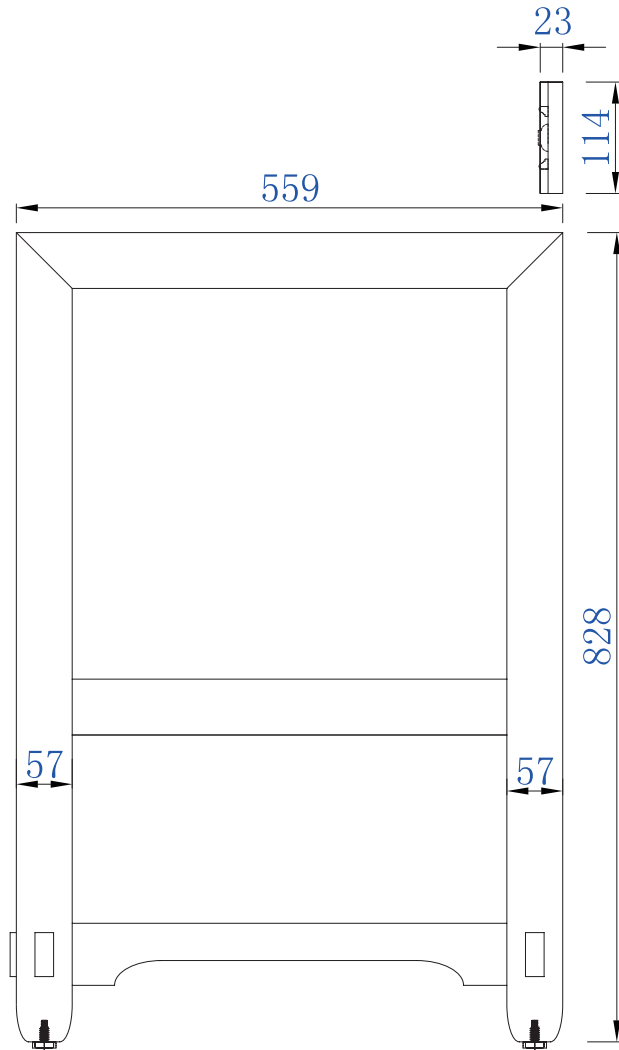

NOTE ONE: Countertops are not shown in these diagrams. (Cabinet Only)

NOTE TWO: Wood Backsplash (Shown) is designed for the molding detail to align with sinks in James Martin's Optional Countertops.
Customers' own countertops and sinks may align differently.

Please consult our website for Countertop Diagrams: www.jamesmartinvanities.com

Version: 202005